

## Serena Roller Shades

## Triathlon Roller Shades

Lutron smart roller shades start, move, and stop smoothly and quietly, providing privacy and light control at the touch of a button.

### Features

- Battery-powered, wired power, and cordless manual models available
- Industry leading battery performance\*
- Ultra-quiet operation: 38 dBA measured 3 ft (1 m) from the drive
- Precise drive is capable of stopping at 0.125 in (3 mm) intervals throughout the entire travel of the shade
- Drive maintains consistent shade speed throughout the battery life cycle by monitoring battery voltage and compensating for fabric thickness
- Easy installation and maintenance
- Built in wireless communication using ClearConnect RF technology
- Wireless control range: 30 ft (9 m)
- Symmetrical light gaps, as small as 1/2 in (12 mm)

**NOTE:** At high aspect ratio (tall and narrow) shade sizes, Lutron may apply a fabric deduction, which increases the size of the light gaps to compensate for the increased probability of telescoping

\* Battery performance details are available in your shade ordering tool.

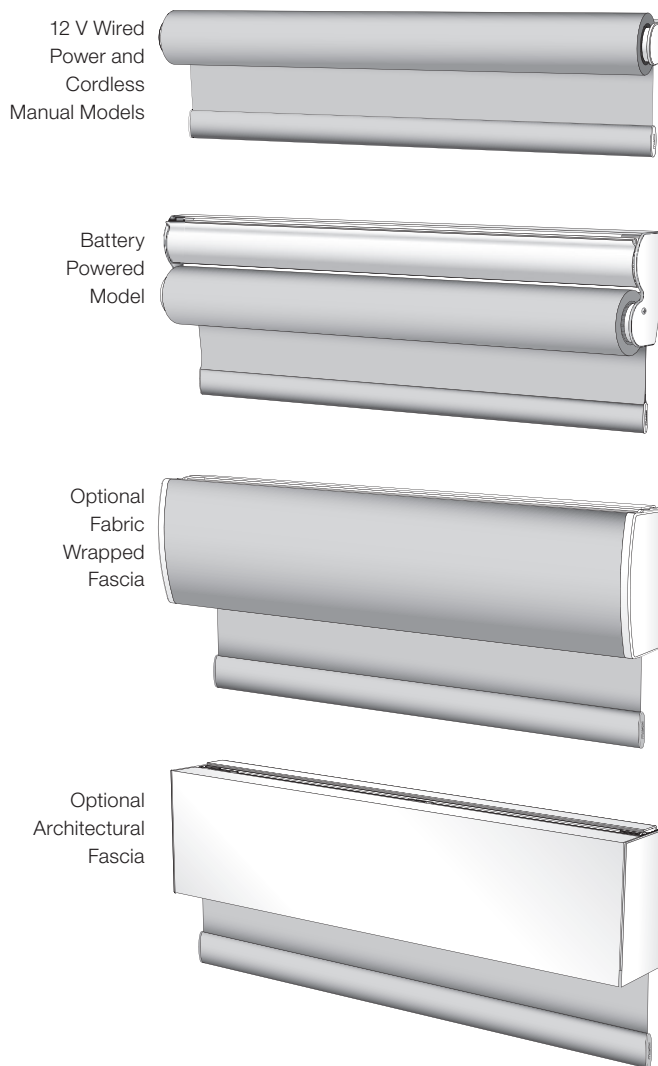

## Specifications

### Regulatory

- cULus listed (E135084)
- FCC (USA)
- IC (Canada)
- CFT (Mexico)
- CE Mark (European Union)
- FCC Certified (Hong Kong)

### Ratings

- Operating Voltage: 6-12 V<sub>DC</sub>
- Operating Wattage: 5 W
- Torque: 2.0 in•lb
- Speed: 3.6 in/sec

### Compatible Controls

#### Serena Models

- Pico wireless control
- 4-Group RF Shade Remote Control
- Caséta

#### Triathlon Models

- Pico wireless control
- 4-Group RF Shade Remote Control
- seeTouch RF keypads
- GRAFIK Eye QS
- RadioRA 2
- RA2 Select
- HomeWorks QS
- Caséta (Smart Bridge Pro)

### Environment

- Temperature: 32° F to 104° F (0° C to 40° C)
- For indoor use only
- Relative Humidity: <90% non-condensing

<b>Job Name:</b>	<b>Model Numbers:</b>
<b>Job Number:</b>	

**Shade Mounting Rail (top back cover):**

(for all battery-powered shades and shades with optional fascia)

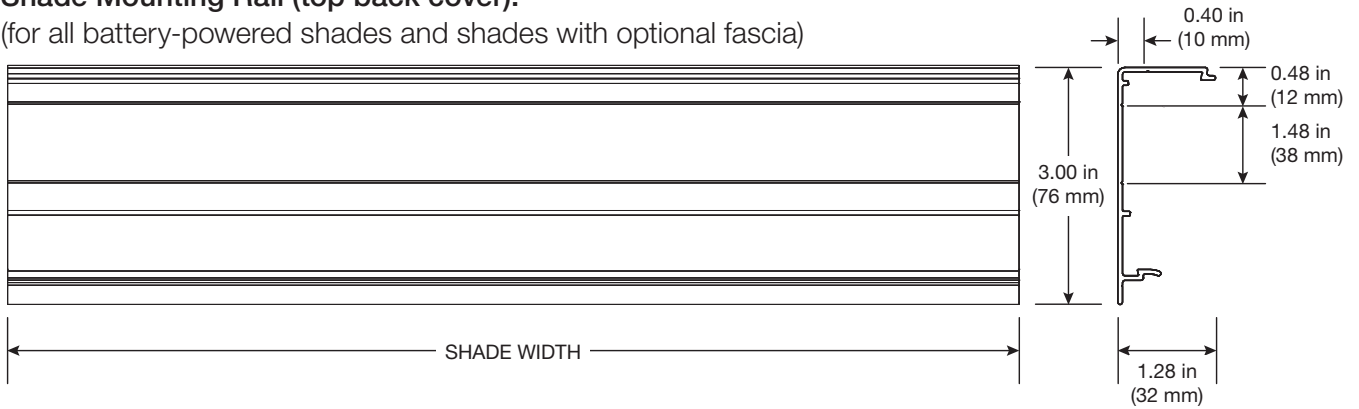

**Wired Power and Cordless Manual Models**

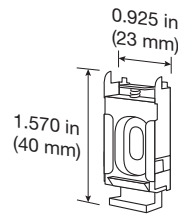
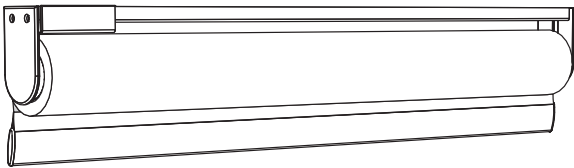

Mounting Bracket

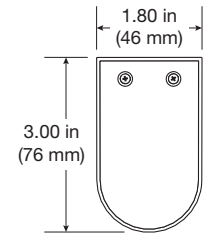

Shade Bracket

**Optional Fabric Wrapped Fascia:**

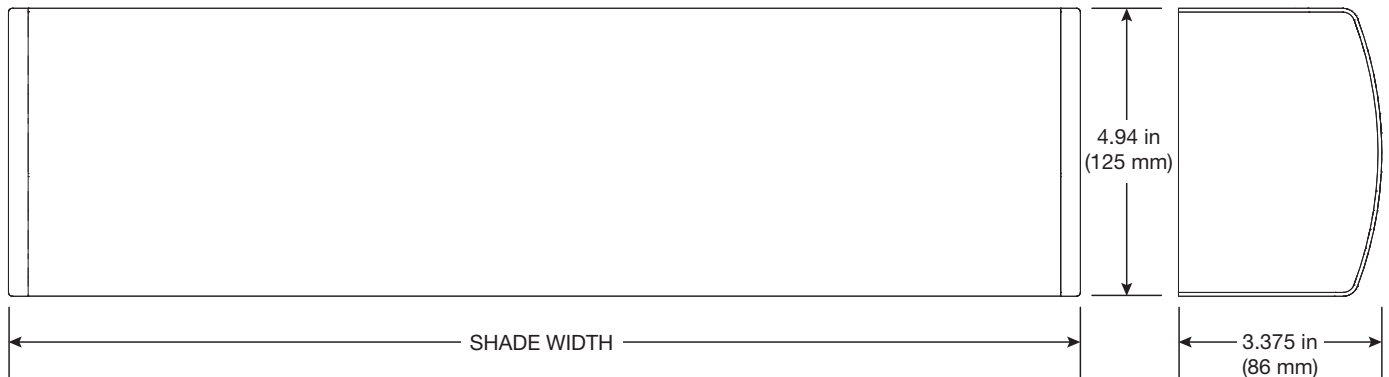

**Optional Architectural Fascia:**

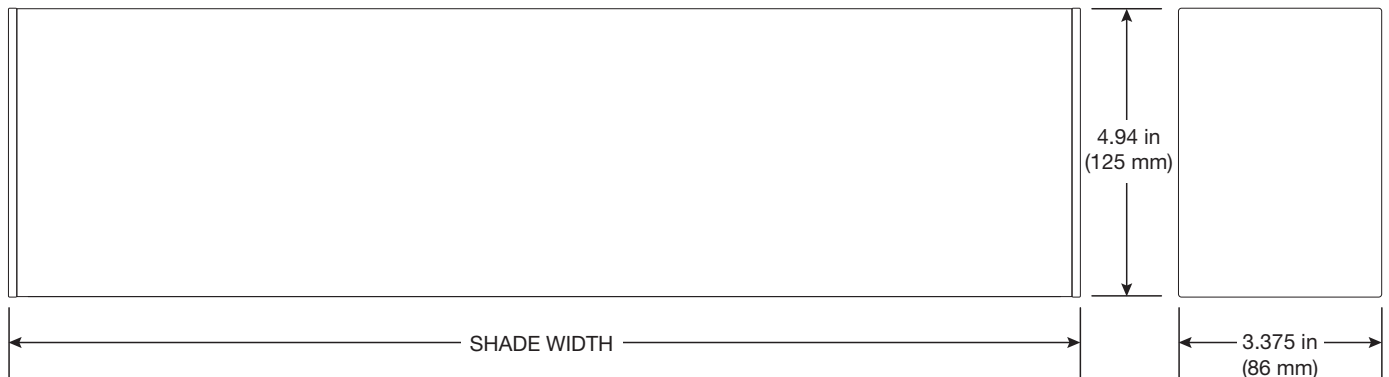

Job Name:	Model Numbers:
Job Number:	

### Mounting Options

Depending on the window dimensions, the shade can be mounted inside the window frame or outside the window frame. Battery-powered and wired power shades are available from 19.5" up to 108" wide, depending on configuration.

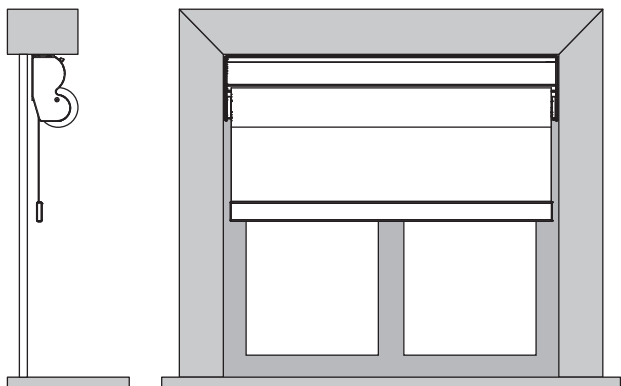

#### INSIDE MOUNT

The window jamb must be at least 3 in (76 mm) deep to fully recess the shade. With optional fascia, the window jamb must be at least 3.5 in (76 mm) deep to fully recess the shade and the fascia.

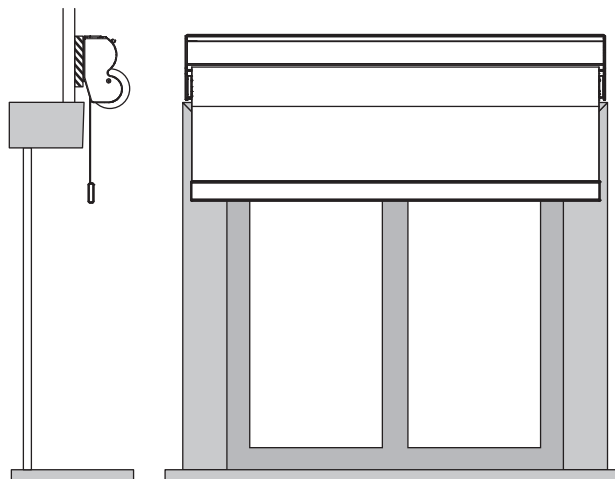

#### OUTSIDE MOUNT ABOVE TRIM

Spacer blocks are included when outside mount above trim is indicated.

Depending on the size of the shade and the depth of the trim, or the roll direction of the shade, it may be possible to mount the shade directly to the wall above the trim without using the spacer blocks.

In this arrangement, the top of the shade mounting rail (top back cover) must be a minimum of 5 1/4 in (133 mm) above the top of the trim, as shown below.

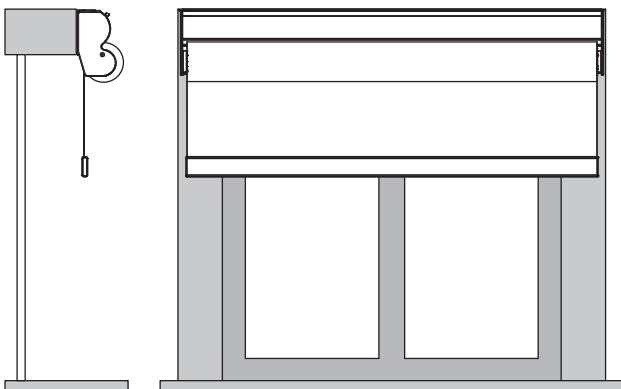

#### OUTSIDE MOUNT ON TRIM

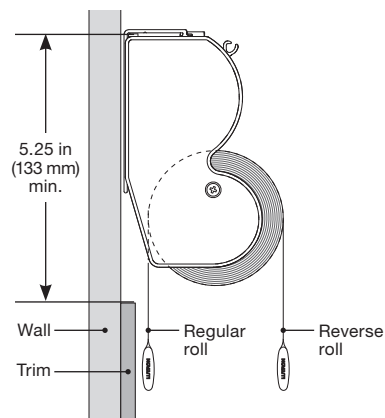

**NOTE:** Optional fascia not available with reverse roll.

Job Name:	Model Numbers:
Job Number:	

## Power Options

### Battery power

- Batteries are not included.
- D-Cell Alkaline batteries required.

Quantity varies with shade size and mounting configuration.

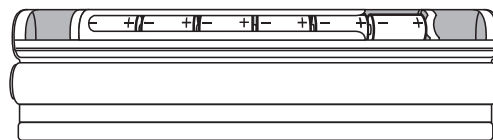

Shade Width	Batteries Required	
19 1/2 in (495 mm) to 25 15/16 in (659 mm)	6 D-Cell Alkaline	
26 in (660 mm) to 37 9/16 in (954 mm)	8 D-Cell Alkaline	<b>with Battery Boost Option</b>
37 5/8 in (956 mm) to 47 1/16 in (1195 mm)	8 D-Cell Alkaline	12 D-Cell Alkaline
47 1/8 in (1197 mm) to 108 in (2743 mm)	8 D-Cell Alkaline	16 D-Cell Alkaline

### NOTES:

The width ranges shown above are for an outside-mount shade without fascia.

Install new D-cell alkaline batteries. Do not mix brands or types. Lutron recommends Duracell® or RAYOVAC® batteries. A diagram on the battery holder shows correct orientation.

Battery Boost option is available for shades wider than 37 1/2 in (953 mm). The Battery Boost feature adds a second battery holder for extended battery life in larger shades and high-use applications. The shade will operate with batteries installed in either battery holder or both battery holders. Extended battery life is realized only when new batteries are installed in both battery holders.

To maintain performance specifications in buildings with 20 or more Lutron Radio Powr Savr Sensors, Lutron recommends powering shades with a wired power supply.

### Plug-in power supply

- Available separately.
- Shades ordered with wired power include a 15 ft (4.5 m) power wire.

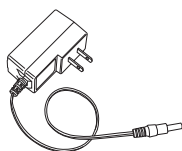

CSPS-P1-1-6-WH =

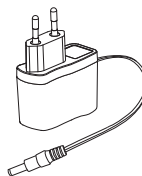

CSPS-P2-1-6-WH =

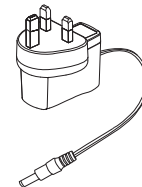

CSPS-P3-1-6-WH =

### Power panel\*

10-output power supply,  
CSPS-P1-10-6 available separately.

**Input Voltage:** 120-240 V~

**Max. input current:** 1.5 A

**Operating frequency:** 50/60 Hz

**Output Voltage:** 12 V

**Output Current:** 5 A

**ESD Protection:** (+/-) 16 kV

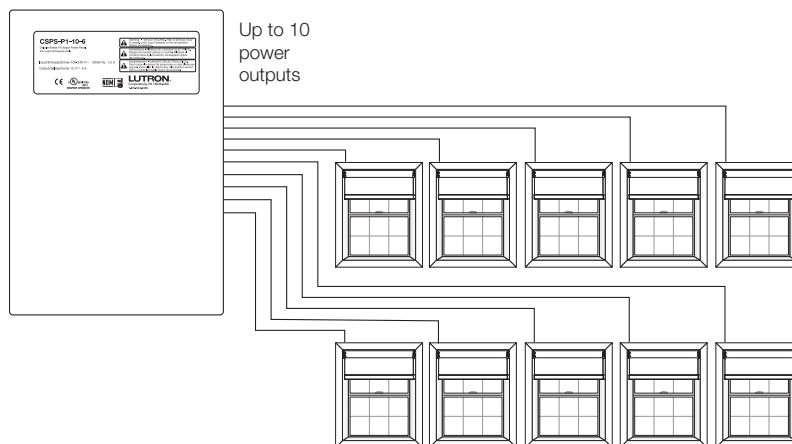

\* Secondary wiring must be of type CL2, CL2P, CL2R, CL2X or other cable with equivalent or better electrical, mechanical, and flammability ratings in accordance with local and national electric code.

## SPECIFICATION SUBMITTAL

Page

<b>Job Name:</b>	<b>Model Numbers:</b>
<b>Job Number:</b>	